



## Inline Filter DFN/DFNF/LFN/LFNF to DIN 24550 up to 350 l/min, up to 400 bar



### 1. TECHNICAL SPECIFICATIONS

#### 1.1 FILTER HOUSING

##### Construction

The filter housings are designed in accordance with international regulations. They consist of a filter head and a screw-in filter bowl. DFN/F and LFNF filters are suitable for flow in both directions.

Standard equipment:

- without bypass valve
- connection for a clogging indicator

#### 1.2 FILTER ELEMENTS

HYDAC filter elements are validated and their quality is constantly monitored according to the following standards:

- ISO 2941
- ISO 2942
- ISO 2943
- ISO 3724
- ISO 3968
- ISO 11170
- ISO 16889

#### Contamination retention capacities in g

LFN, LFNF DFN, DFN/F	Betamicon® (BN4HC)			
	3 µm	6 µm	10 µm	25 µm
40	5.2	5.6	6.3	7.0
63	9.2	9.9	11.1	12.8
100	15.4	16.5	18.6	20.6
160	27.5	29.3	33.1	36.7
250	46.0	49.0	55.2	61.3
400	76.2	81.3	91.4	101.5

LFN, LFNF DFN, DFN/F	Betamicon® (BH4HC)			
	3 µm	6 µm	10 µm	25 µm
40	4.1	4.4	5.2	6.2
63	7.3	7.9	9.2	11.2
100	12.2	13.2	15.5	18.9
160	21.8	23.9	27.8	33.8
250	38.1	41.7	48.6	59.0
400	63.6	69.5	81.0	98.3

Filter elements are available with the following pressure stability values:

Betamicon® (BN4HC):	20 bar
Betamicon® (BH4HC):	210 bar
Wire mesh (W/HC):	20 bar

### 1.3 FILTER SPECIFICATIONS

Nominal pressure	100 bar : all LFN and LFNF 210 bar : DFN 160, 400 400 bar : DFN 40, 63, 100, 250 DFNF 40, 63, 100
Fatigue strength	At nominal pressure 10 <sup>6</sup> cycles from 0 to nominal pressure
Temperature range	-30 °C to +100 °C (-30 °C to -10 °C = 200 bar - only DFN/F)
Material of filter head (and cover plate)	EN-GJS-400-15: DFN/F Aluminium : LFNF/F
Material of filter bowl (tube)	Steel : DFN/F Aluminium : LFNF/F 40, 63 Steel : LFNF/F 100
Type of indicator	VM (Diff. pressure ind. up to 210 bar oper. pressure - not for type LZ) VD (Diff. pressure ind. up to 420 bar oper. pressure)
Pressure setting of the clogging indicator	5 bar (others on request)
Bypass cracking pressure (optional)	7 bar (others on request)

### 1.4 SEALS

NBR (=Perbunan)

### 1.5 INSTALLATION

Inline filter

### 1.6 SPECIAL MODELS AND ACCESSORIES

- With bypass valve
- FPM seals

### 1.7 SPARE PARTS

See Original Spare Parts List

### 1.8 CERTIFICATES AND APPROVALS

On request

### 1.9 COMPATIBILITY WITH HYDRAULIC FLUIDS ISO 2943

- Hydraulic oils H to HLPD DIN 51524
- Lubrication oils DIN 51517, API, ACEA, DIN 51515, ISO 6743
- Compressor oils DIN 51506
- Biodegradable operating fluids VDMA 24568 HETG, HEES, HEPG
- Fire-resistant fluids HFA, HFB, HFC and HFD
- Operating fluids with high water content (> 50 % water content) on request

### 1.10 IMPORTANT INFORMATION

- Filter housings must be earthed.
- When using electrical clogging indicators, the electrical power supply to the system must be switched off before removing the clogging indicator connector.

#### Symbol for hydraulic systems DFN / LFN

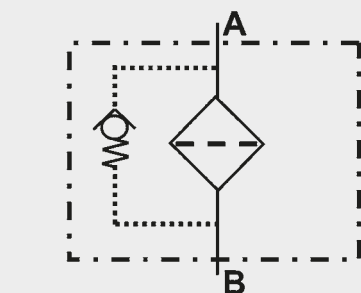

DFNF/  
LFNF

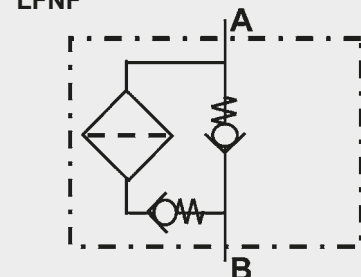

## 2. MODEL CODE (also order example)

DFN BN/HC 250 S F 10 D 1 . X /-L24

### 2.1 COMPLETE FILTER

#### Filter type

DFN, LFN, LFNF, DFNF

#### Filter material of element

BN/HC Betamicon® (BN4HC) BH/HC Betamicon® (BH4HC)  
W/HC Wire mesh

#### Size of filter or element

DFN: 40, 63, 100, 160\*, 250, 400 (\*on request)  
DFNF: 40, 63, 100  
LFN/F: 40, 63, 100

#### Operating pressure

I = 100 bar (LFN and LFNF)  
L = 210 bar (DFN 160, 400)  
S = 400 bar (DFN 40, 63, 100, 250; DFNF 40, 63, 100)

#### Type and size of connection

Type	Connection	Filter size					
		40	63	100	160	250	400
B	G 1/2	●	x	x			
C	G 3/4	x	●	x			
D	G 1	x	x	●			
E	G 1 1/4				●	x	x
F	G 1 1/2				x	●	x
K	DN 40*				x	x	●

● = to DIN 24550  
x = possible ports

\*Flange SAE, 6000 PSI

#### Filtration rating in µm

BN/HC, BH/HC: 3, 6, 10, 25 W/HC: 25, 50, 100, 200

#### Type of clogging indicator

Y plastic blanking plug in indicator port  
A steel blanking plug in indicator port  
B visual  
C electrical  
D visual and electrical  
LZ visual-mechanical / electrical

for other clogging indicators,  
see brochure no. 7.050../..

#### Type code

1 DFN / DFNF  
2 LFN / LFNF

#### Modification number

X the latest version is always supplied

#### Supplementary details

B. bypass cracking pressure (e.g. B7 = 7 bar); without details = without bypass valve  
L... light with appropriate voltage (24V, 48V, 110V, 220V) only for clogging indicators  
LED 2 light emitting diodes up to 24 Volt type D  
AV LZ indicator with plug to AUDI and VW specification  
BO LZ indicator with plug and pin connections to BMW and Opel specification (M12x1)  
CN LZ indicator with plug to DIN 43651 with 3 LEDs (CNOMO specification)  
DB LZ indicator with plug to DIN 43651 with 3 LEDs (Daimler-Benz specification)  
D4C LZ with plug and connector to Daimler-Chrysler specification and cold start suppression 30°C  
BO-LED as for BO, but with diode strip  
SO368 inlet and outlet G 1/2 (without RI connection; only for DFN/F 40, 63, 100)  
V FPM seals  
W suitable for HFA and HFC emulsions

### 2.2 REPLACEMENT ELEMENT

0250 DN 010 BN4HC /-V

#### Size

0040, 0063, 0100, 0160, 0250, 0400

#### Type

DN

#### Filtration rating in µm

BN4HC, BH4HC: 003, 006, 010, 025 W/HC: 025, 050, 100, 200

#### Filter material

BN4HC, BH4HC, W/HC

#### Supplementary details

V (for descriptions, see Point 2.1)

### 2.3 REPLACEMENT CLOGGING INDICATOR

VM 5 D . X /-L24

#### Type of indicator

VM differential pressure indicator up to 210 bar operating pressure (not for type LZ)  
VD differential pressure indicator 420 bar operating pressure

#### Pressure setting

5 standard 5 bar, others on request

#### Type of clogging indicator (see Point 2.1)

#### Modification number

X the latest version is always supplied

#### Supplementary details

L..., LED, V, W (for descriptions, see Point 2.1)

### 3. FILTER CALCULATION / SIZING

The total pressure drop of a filter at a certain flow rate Q is the sum of the housing  $\Delta p$  and the element  $\Delta p$  and is calculated as follows:

$$\Delta p_{\text{total}} = \Delta p_{\text{housing}} + \Delta p_{\text{element}}$$

$$\Delta p_{\text{housing}} = (\text{see Point 3.1})$$

$$\Delta p_{\text{element}} = Q \cdot \frac{SK^*}{1000} \cdot \frac{\text{viscosity}}{30}$$

(\*see Point 3.2)

For ease of calculation, our Filter Sizing Program is available on request free of charge.

**NEW:** Sizing online at [www.hydac.com](http://www.hydac.com)

#### 3.1 $\Delta p$ -Q HOUSING CURVES BASED ON ISO 3968

The housing curves apply to mineral oil with a density of 0.86 kg/dm<sup>3</sup> and a kinematic viscosity of 30 mm<sup>2</sup>/s. In this case, the differential pressure changes proportionally to the density.

**DFN 40, 63, 100**  
**LFN 40, 63, 100**

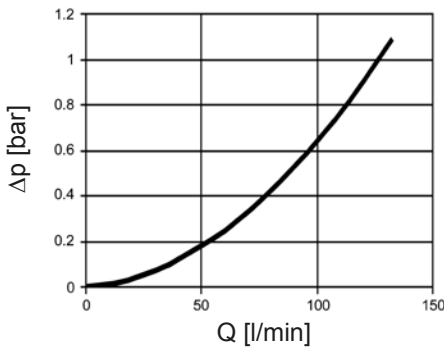

**DFNF / LFN 40, 63, 100**

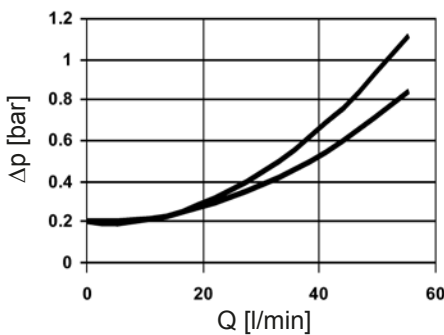

**DFN 160, 250, 400**

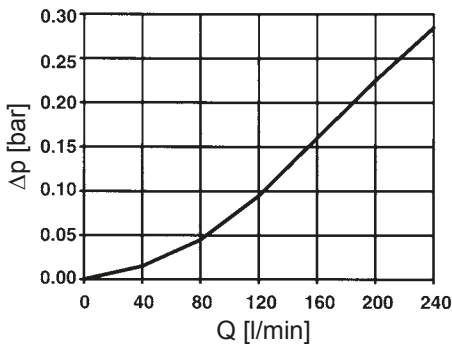

### 3.2 GRADIENT COEFFICIENTS (SK) FOR FILTER ELEMENTS

The gradient coefficients in mbar/(l/min) apply to mineral oils with a kinematic viscosity of 30 mm<sup>2</sup>/s. The pressure drop changes proportionally to the change in viscosity.

LFN/F	BH4HC				W/HC
DFN/F	3 μm	6 μm	10 μm	25 μm	-
40	40.4	24.8	16.4	10.9	0.966
63	29.0	18.2	11.7	7.6	0.54
100	19.0	11.7	7.7	5.3	0.325
160	8.0	5.1	3.8	2.5	0.168
250	5.4	3.4	2.8	1.9	0.101
400	3.4	2.1	1.7	1.1	0.061

**BN4HC: DFN / DFNF / LFN / LFN 40**

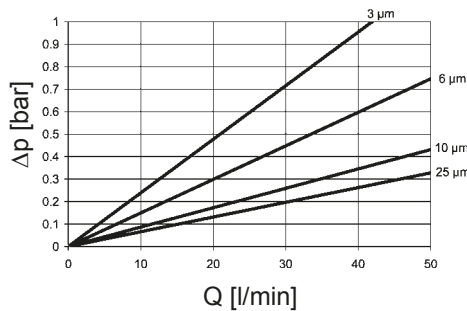

**BN4HC: DFN / DFNF / LFN / LFN 63**

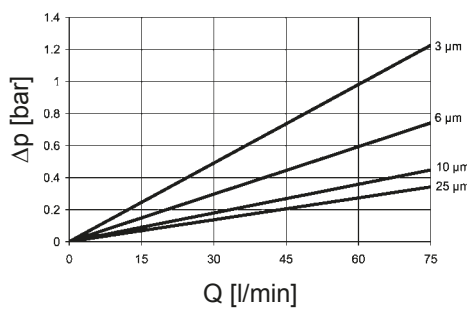

**BN4HC: DFN / DFNF / LFN / LFN 100**

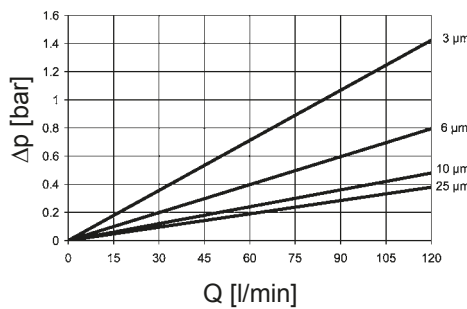

**BN4HC: DFN 160**

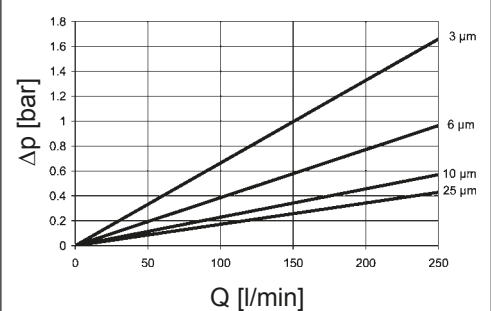

**BN4HC: DFN 250**

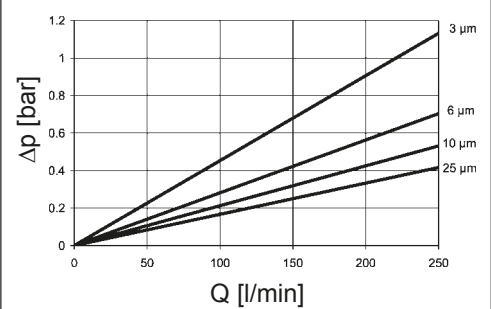

**BN4HC: DFN 400**

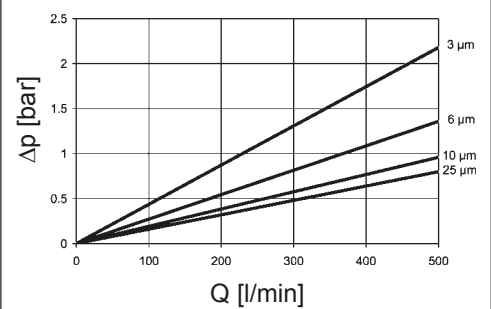

## 4. DIMENSIONS

LFN, LFNF

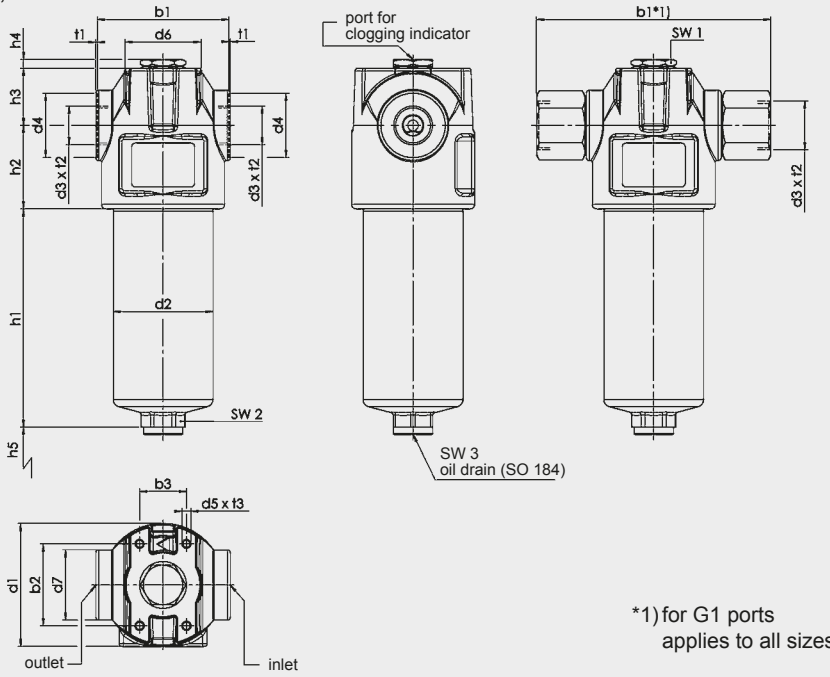

Type	Weight incl. element [kg]	Volume of pressure chamber [l]
LFN 40	1.45	0.26
LFN 63	1.8	0.40
LFN 100	4.3	0.50
LFNF 40	1.45	0.26
LFNF 63	1.8	0.40
LFNF 100	4.3	0.50
DFN 40	5.0	0.22
DFN 63	6.0	0.33
DFN 100	6.25	0.50
DFN 160	20.0	1.10
DFN 250	22.0	1.70
DFN 400	26.5	2.70
DFNF 40	5.0	0.22
DFNF 63	6.0	0.33
DFNF 100	6.25	0.50

Type	b1	b2	b3	d1	d2	d3	d4	d5	d6	d7	h1	h2	h3	h4	h5	SW1	SW2	t1	t2	t3
LFN 40	90	56	32	84	68	G 1/2	34	M6	52	48	90	57	39	6	75	27	27	1	14	9
LFN 63	90	56	32	84	68	G 3/4	44	M6	52	48	150	57	39	6	75	27	27	1	17	9
LFN 100	160 <sup>*1)</sup>	56	32	84	65	G 1	-	M6	52	48	245.5	57	39	6	75	27	27	-	24.5	9
LFNF 40	90	56	32	84	68.2	G 1/2	34	M6	52	48	90	57	39	6	75	27	27	1	14	9
LFNF 63	90	56	32	84	68.2	G 3/4	44	M6	52	48	150	57	39	6	75	27	27	1	17	9
LFNF 100	160 <sup>*1)</sup>	56	32	84	65	G 1	-	M6	52	48	245.5	57	39	6	75	27	27	-	24.5	9

### DFN / DFNF 40 - 100

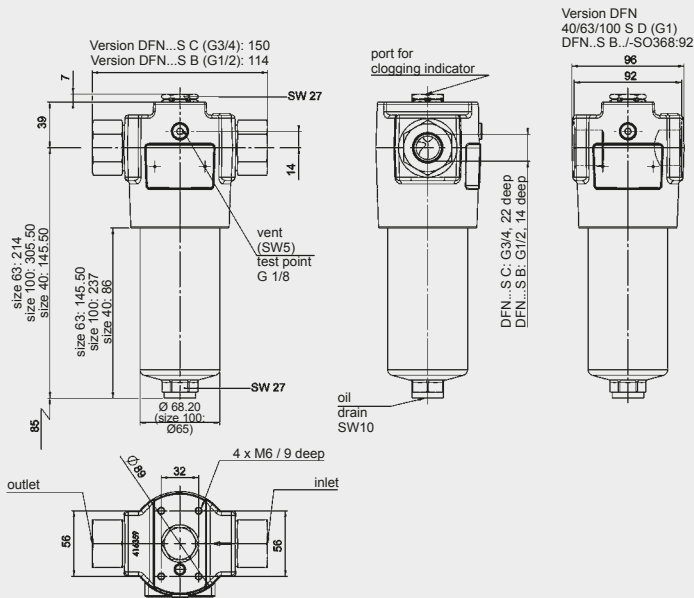

### DFN 160 - 400

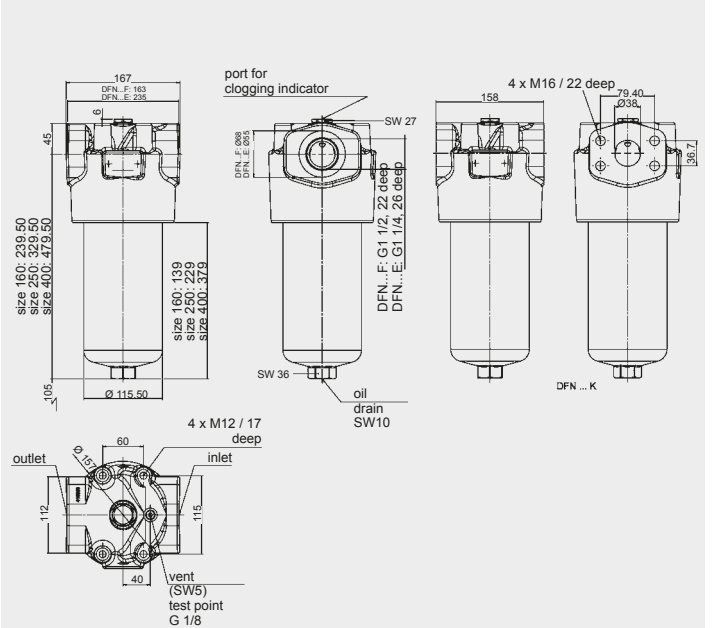

## NOTE

The information in this brochure relates to the operating conditions and applications described.  
For applications or operating conditions not described, please contact the relevant technical department.  
Subject to technical modifications.

**HYDAC Filtrertechnik GmbH**  
Industriegebiet  
**D-66280 Sulzbach/Saar**  
Tel.: 0 68 97 / 509-01  
Fax: 0 68 97 / 509-300  
Internet: [www.hydac.com](http://www.hydac.com)  
E-Mail: [filter@hydac.com](mailto:filter@hydac.com)